

1757.4

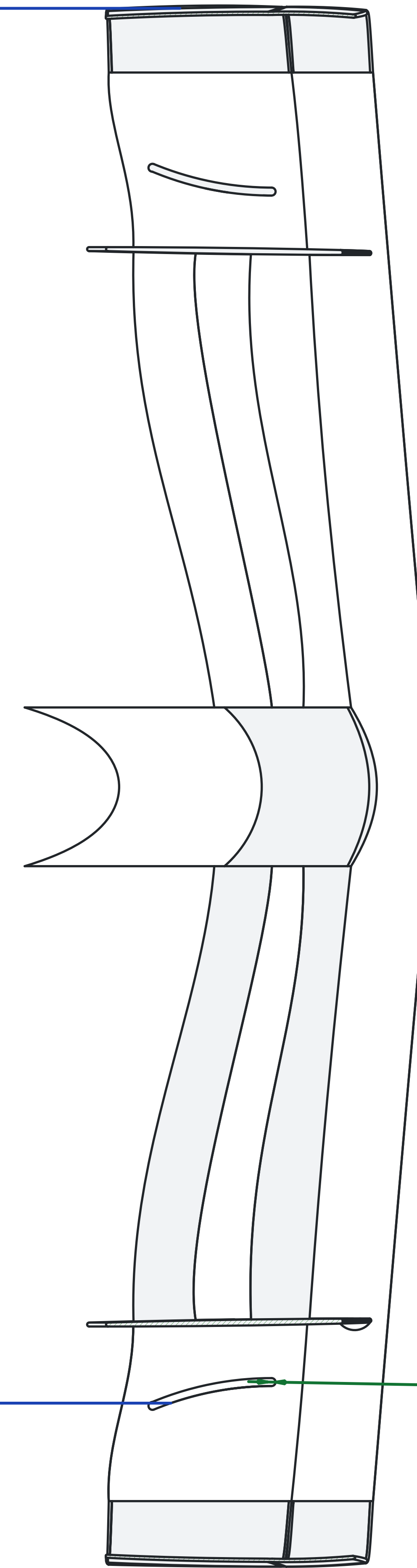

2290.1

Ø10.0