

834.6

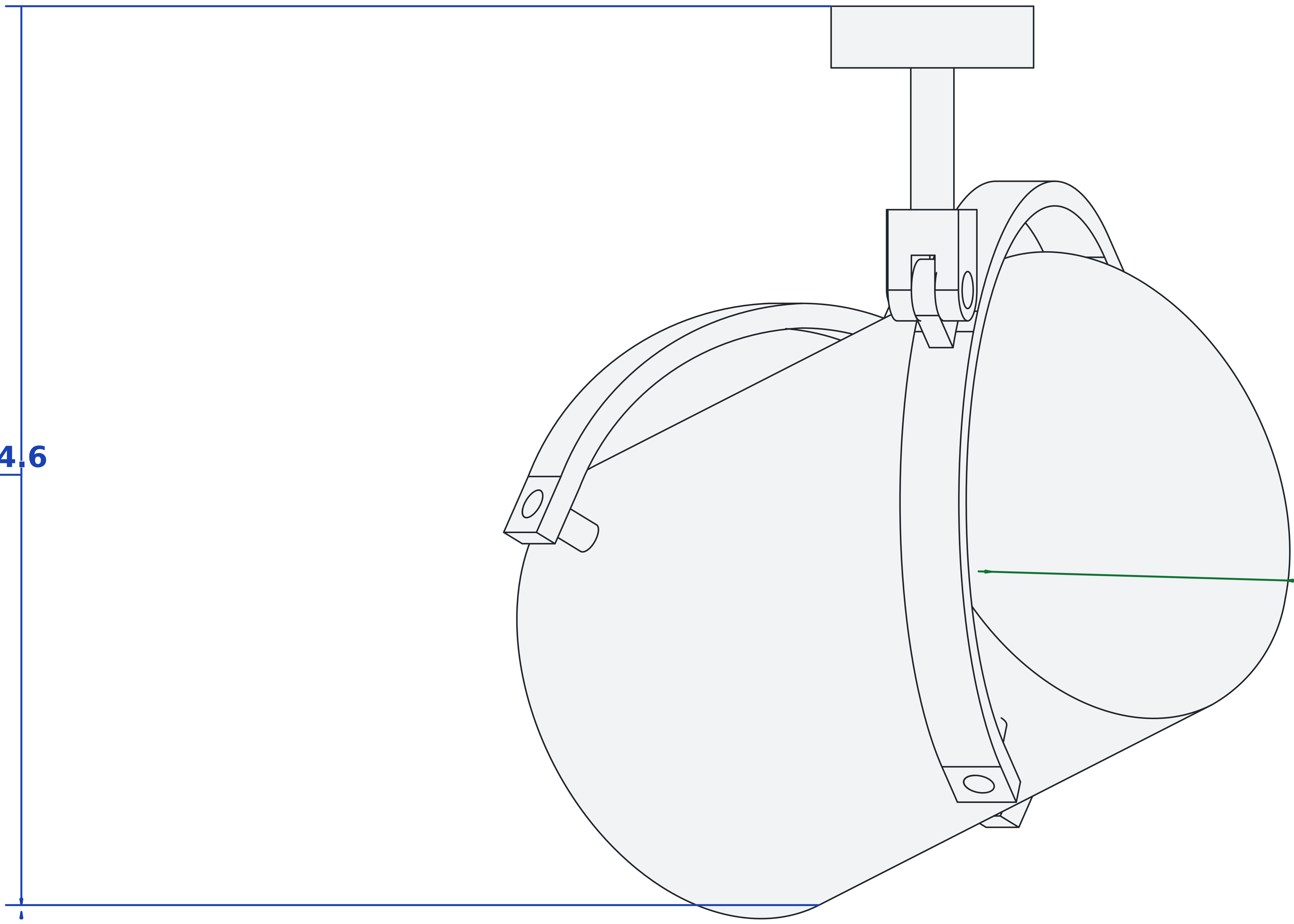

Ø274.4