

282.1

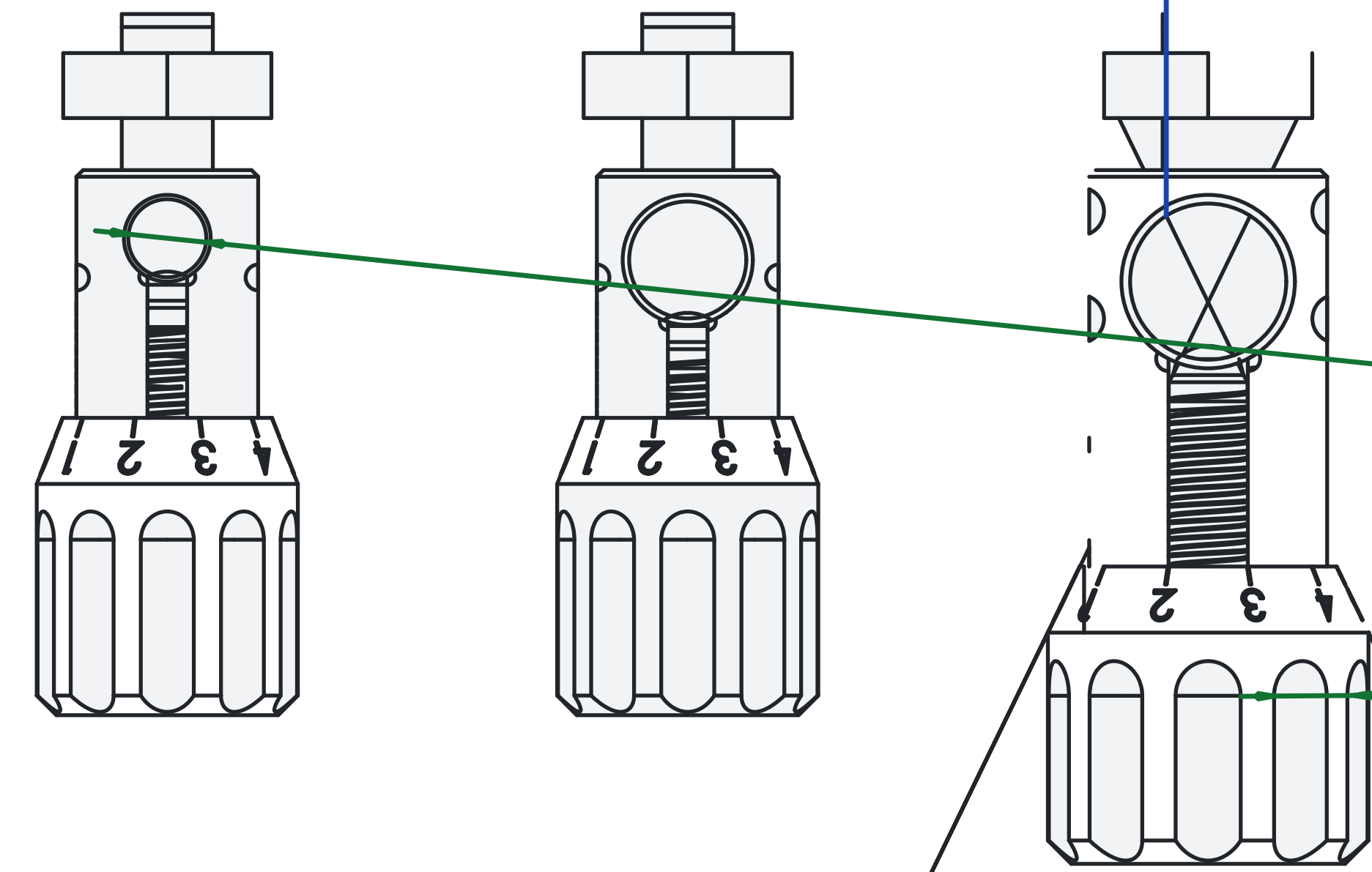

$\text{Ø}7.0$

$\text{Ø}7.2$

