

328.3

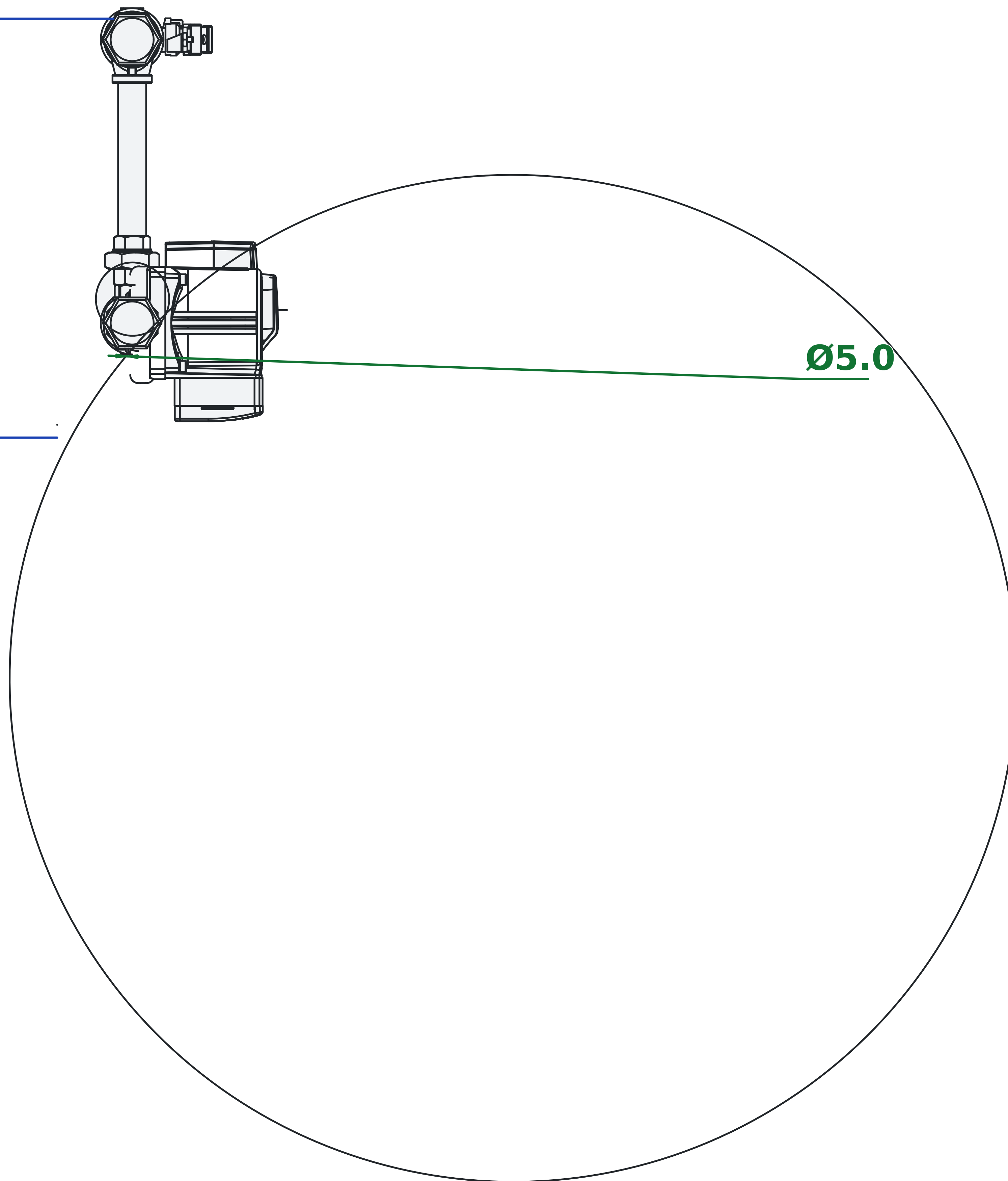

Ø5.0