

Ø9.1

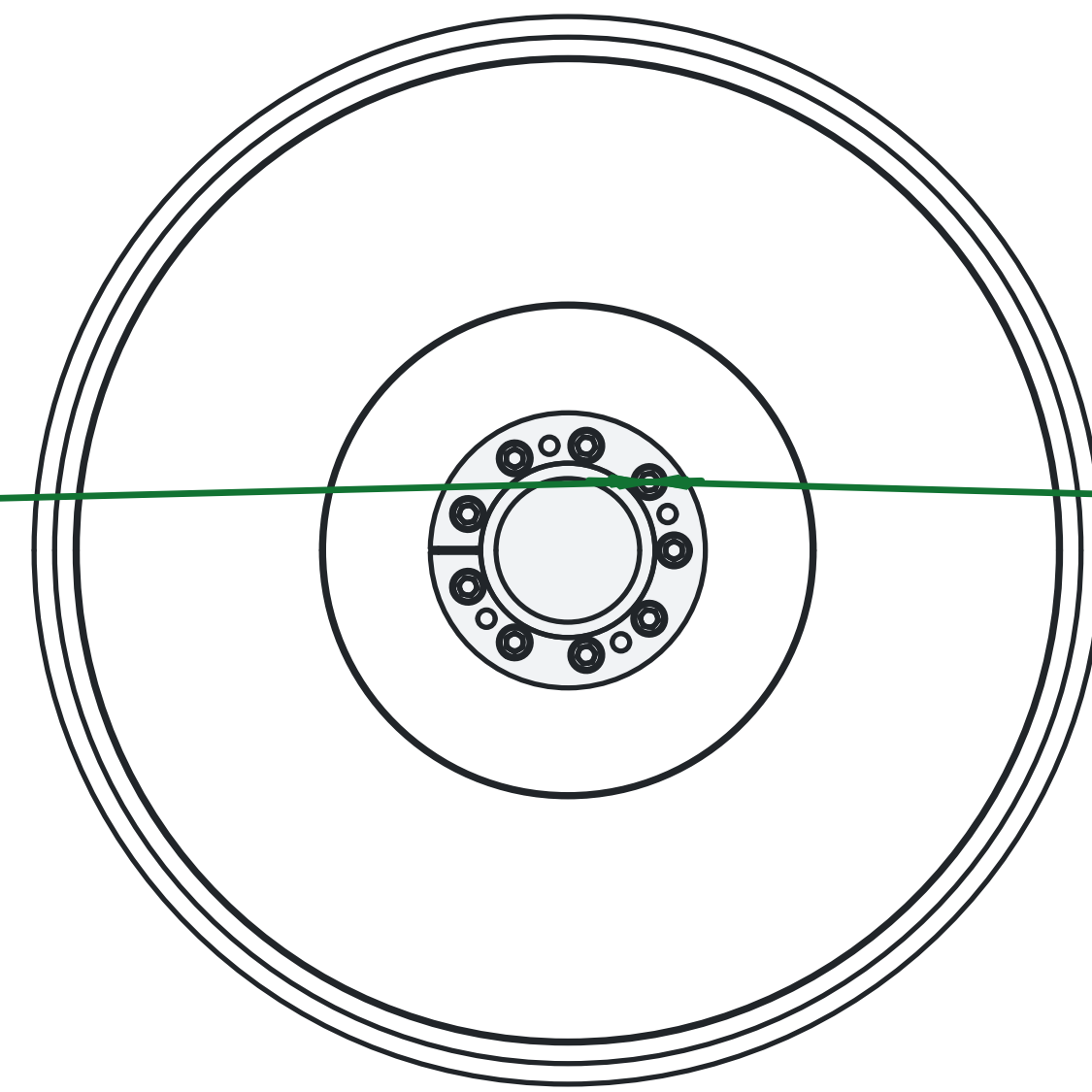

Ø17.9