

Ø144.0

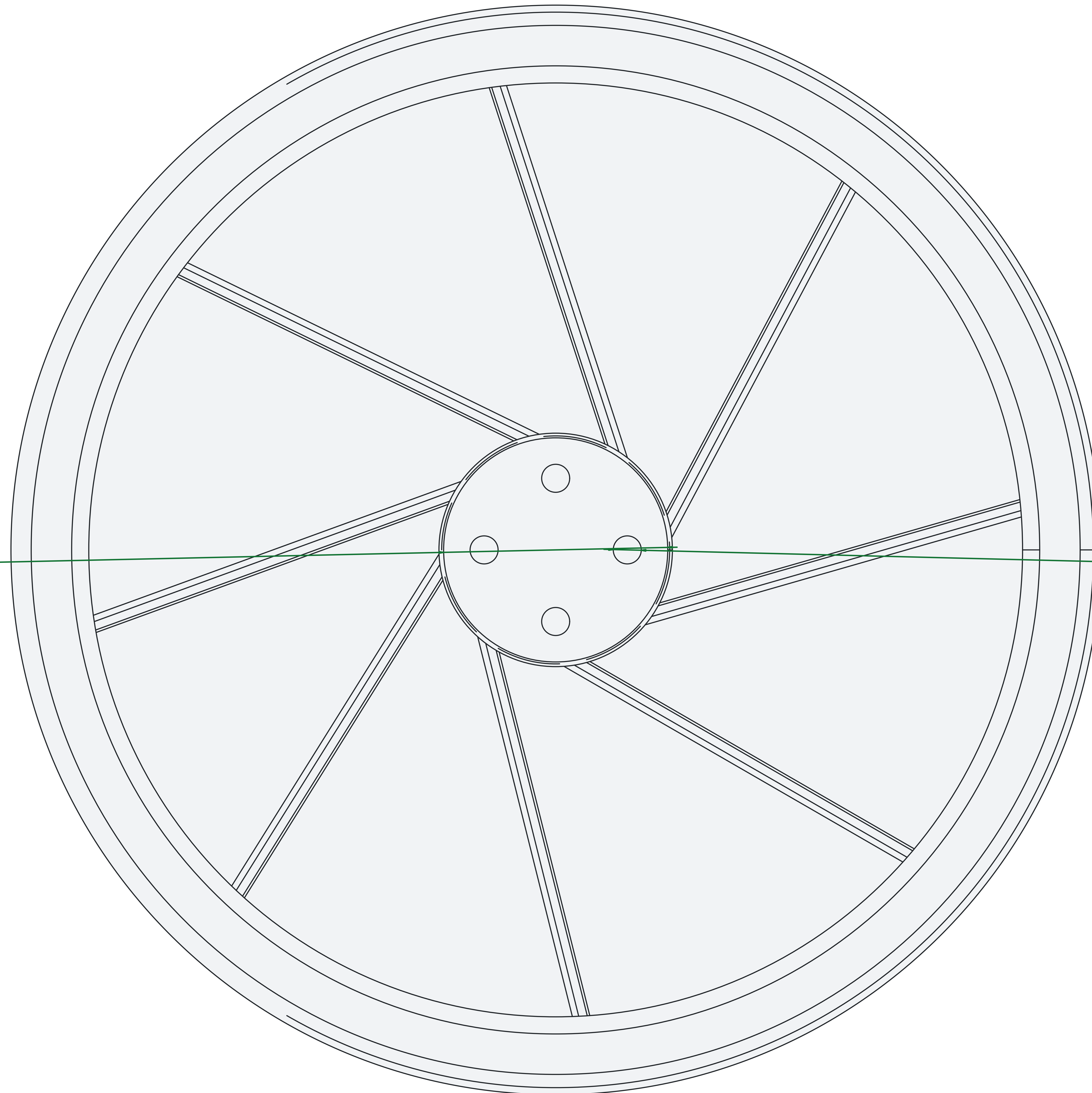

Ø18.0