

103.4

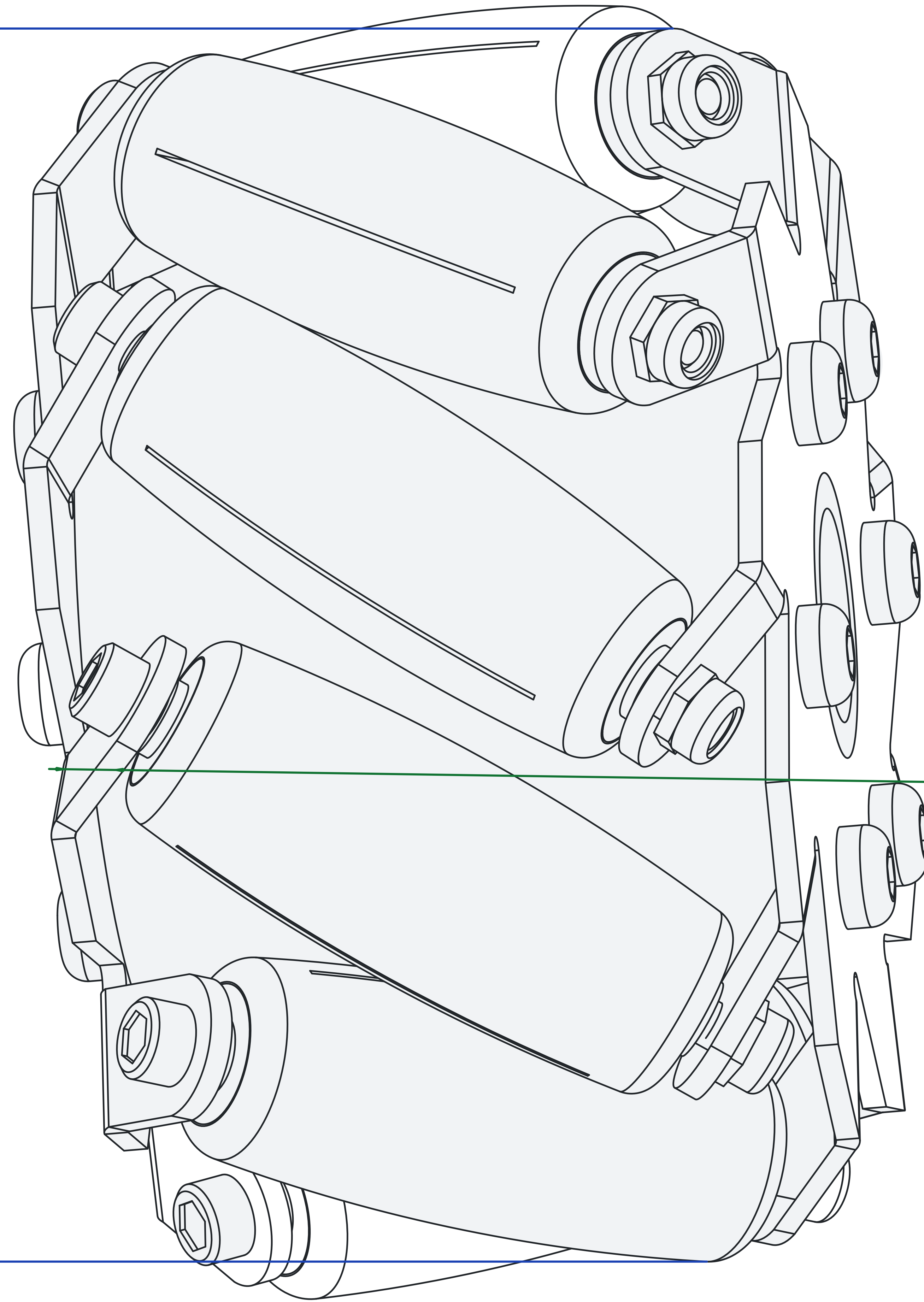

Ø4.4