

Ø111.3

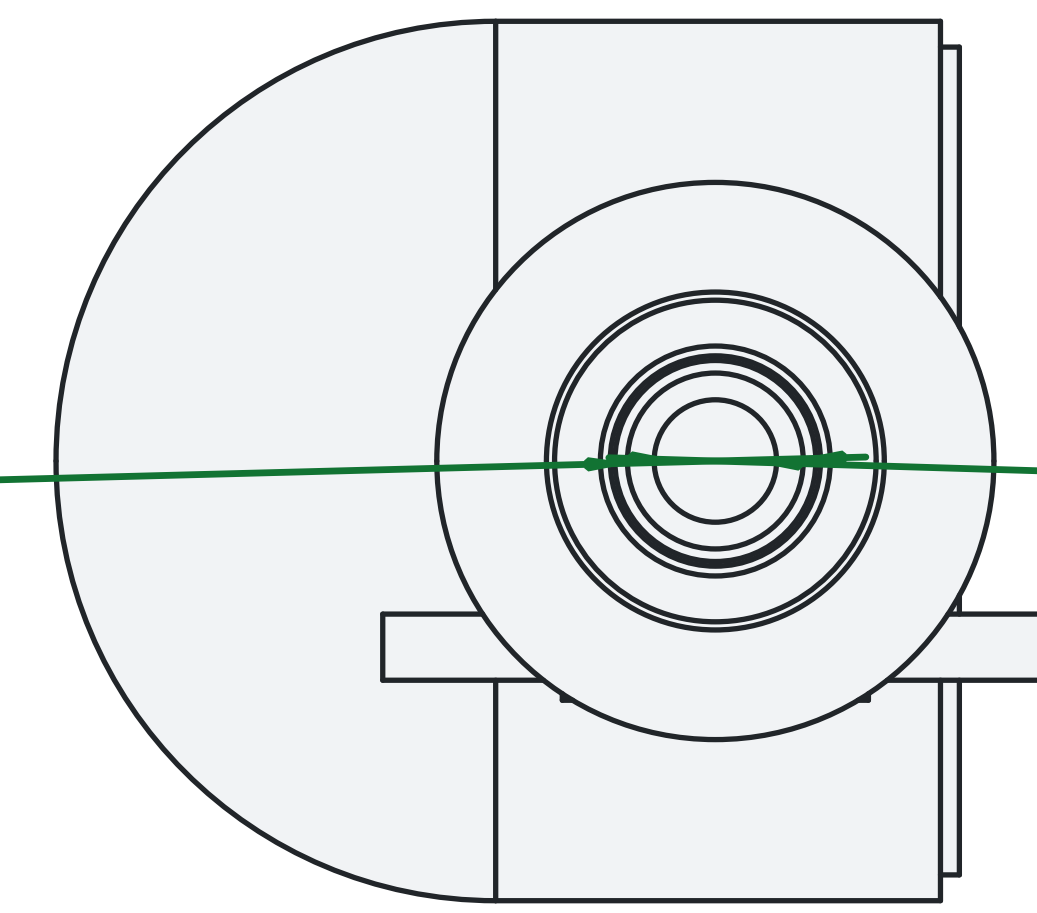

Ø64.8