

0.0

445.6

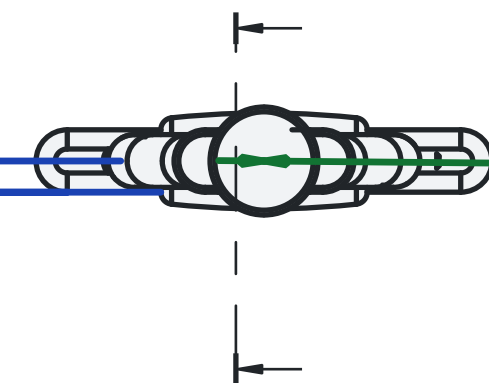

Ø0.0