

0.0

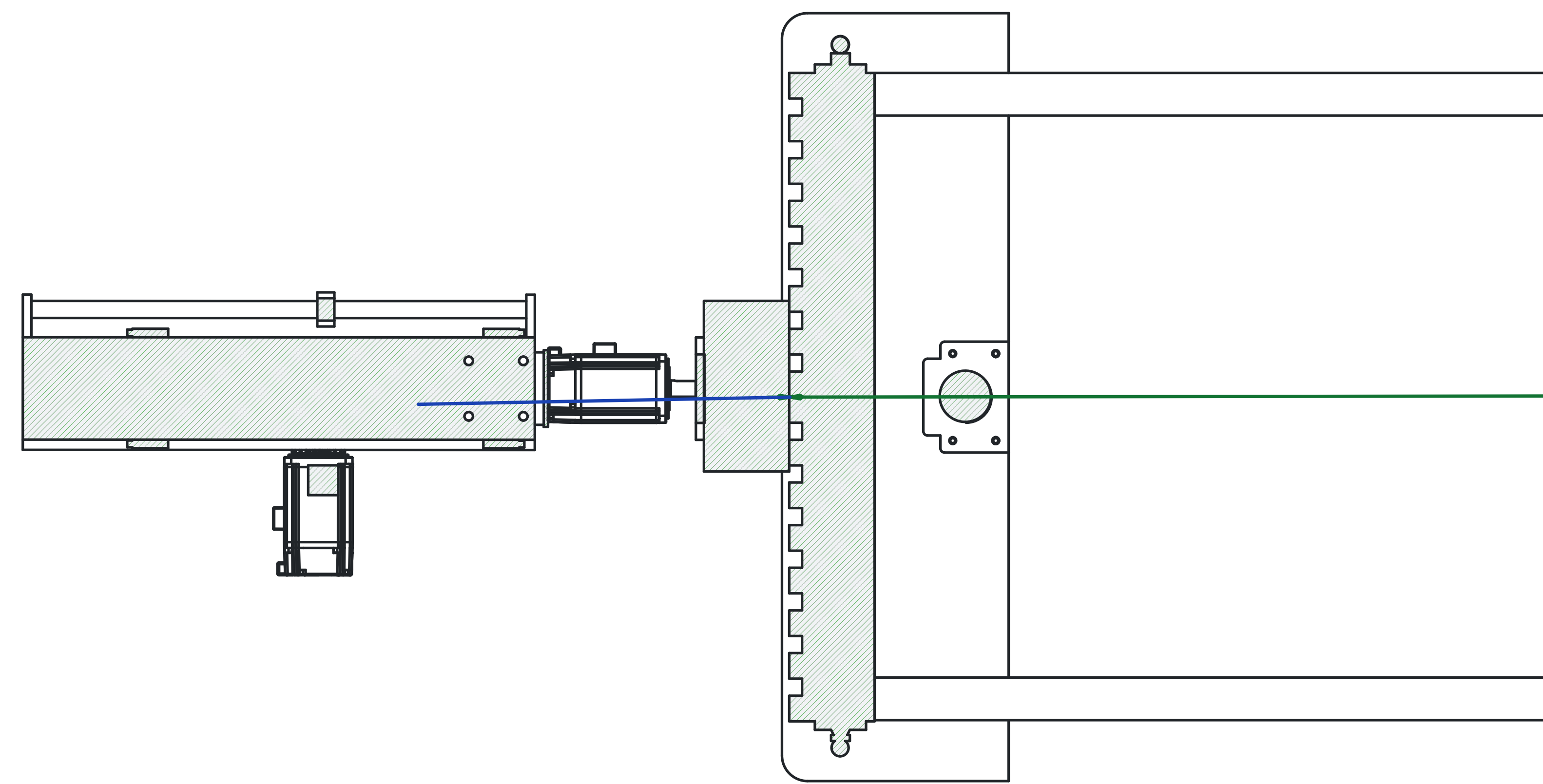

Ø0.0